件 : SU-01-19-A-07-A01B: 02: 2018.11.21

1 共 3

## PD45-TO25-BL-2pin Series

### Features:

- Low Voltage Operation
- Low Capacitance and High Speed with a PIN Structure
- Low Dark Current
- Excellent Stability

### Applications:

- G E
- G F C
- SONE SDH OC

### Specifications:

Reverse Voltage	$V_R$	—	20	V
Forward Current	$I_F$	—	10	mA
Max. Optical Input Power	$P_{MAX}$	—	3	mW
Operating Temperature	Top	-40	+85	°C
Storage Temperature	Tstg	-40	+85	°C
Lead Solder Temperature	—	—	260	°C
Lead Solder Time	—	—	10	s

: ( °C )

Active Diameter	D	—	—	45	—	μm	
Bandwidth	BW	$V_R=5V$	8	10	—	GHz	
Responsivity	@1310nm	R	$V_R=5V$	0.75	0.8	—	A/W
	@1550nm	R	$V_R=5V$	0.8	0.85	—	A/W
Dark Current	ID	$V_R=5V$	—	1	5	nA	
Chip Capacitance	$C_{chip}$	$V_R=5V, f=1MHz$	—	0.11	0.13	pF	
Optical Spectrum Response Range	$\lambda$	—	1100	—	1650	nm	
Operating Voltage	V	—	—	-5	—	V	



### Mechanical Dimension and Pin Assignment:

#### Type A

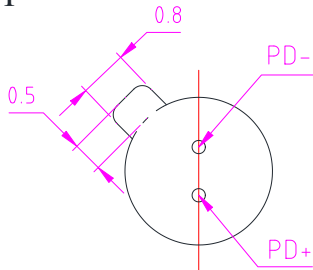

Bottom View

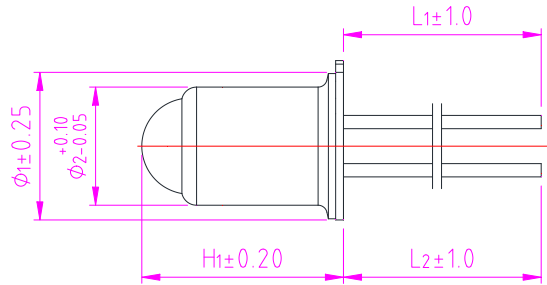

#### Type B

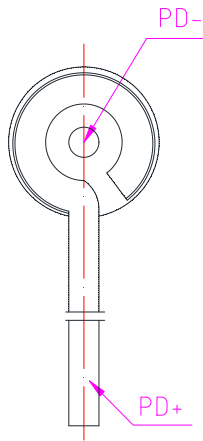

Bottom View

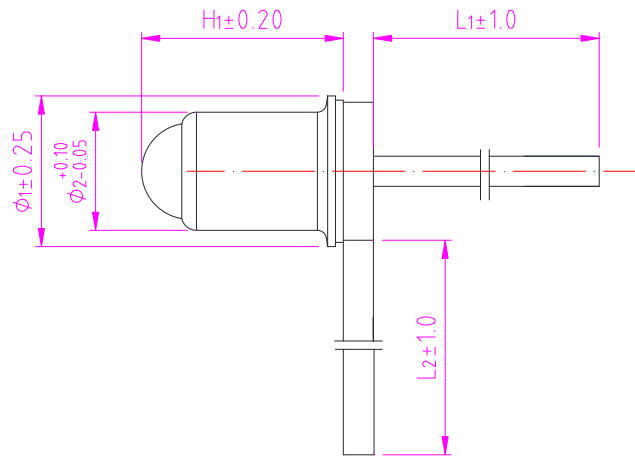

#### Type C

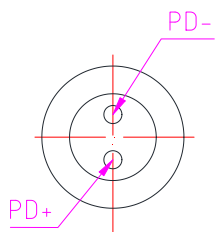

Bottom View

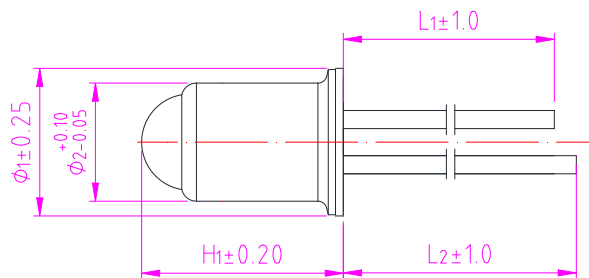

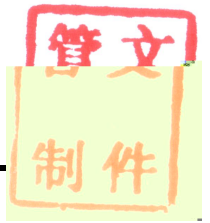
件 : SU-01-19-A-07-A01B: 02: 2018.11.21

3 共 3

## Standard Product List:

Product name	$\Phi_1$ (mm)	$\Phi_2$ (mm)	H <sub>1</sub> (mm)	L <sub>1</sub> (mm)	L <sub>2</sub> (mm)	Received light form
PD45-TO25-BL(High)-2pin-A	2.5	1.96	3.35	12.7	12.7	Divergent light
PD45-TO25-BL(High)-2pin-B	2.5	1.96	3.35	14.0	14.0	
PD45-TO25-BL(High)-2pin-C	2.5	1.96	3.35	15.52	17.52	
PD45-TO25-BL(Short)-2pin-A	2.5	1.96	2.92	12.7	12.7	Parallel light
PD45-TO25-BL(Short)-2pin-B	2.5	1.96	2.92	14.0	14.0	
PD45-TO25-BL(Short)-2pin-C	2.5	1.96	2.92	15.52	17.52	

- Standard and custom designs to suit your systems.

## Order Information:

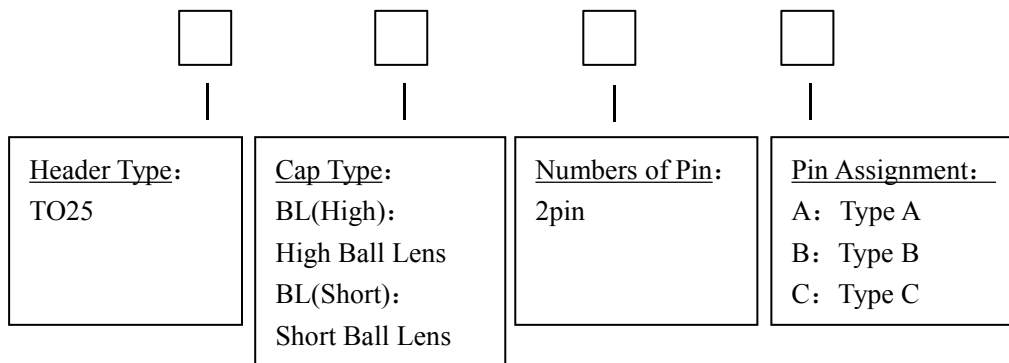

SAN-U owns the authority for final explanation of all information contained in this document, which is subject to change without notice. All the information was obtained in particular environments; and SAN-U will not be responsible for the performance of the customers' actual operating environments. All information contained is only for the users' reference and shall not be considered as warranted characteristics. SAN-U will not be liable for damages arising directly or indirectly which from any use of the information contained in this document.

Address: N501-505 Weiye Bldg., Xiamen Pioneering Park For Overseas Chinese Scholars, Xiamen, Fujian, China

Tel: +86-592-3898601, 3898608, 5318000

Fax: +86-592-5703588

Email: sales@san-u.com

<http://www.san-u.com>